

# An Introduction to Micro/Nano-Bubbles and their Applications

TOMOHIRO MARUI

Nano Bubble Technologies LLC  
 General Manager, Technical Department (Futyu Laboratory)  
 3-7-5 Futyu town Futyu city  
 183-0055 Tokyo, JAPAN

## ABSTRACT

Micro-bubbles gradually decrease in size due to the dissolution of interior gases by the surrounding liquid and eventually disappear, leaving some Nano-Bubbles. It has been proved that free radicals are generated during the collapsing of Micro-bubbles.

The present introduction focuses on the biological application of Micro/Nano-bubbles, whose practical bio-applications, development of cell-level biological treatment, and concept of cell manipulating device in the next stage of the development are introduced. In addition, the future application of Micro/Nano-bubbles to Bio-computing systems is also discussed.

**Keywords:** micro/nano-bubbles, radicals, fermentation, ES-cells, iPS-cells, Taylor vortex, Couette-Taylor reactor, cell-sorting, bio-computer, bio-computing.

## 1. INTRODUCTION

Both Scientific researches and practical applications of Micro/Nano-bubbles were greatly promoted by Hirofumi Ohnari (Tokuyama National College of Technology, CEO of Nanoplanet), Masayoshi Takahashi (National Institute of Advanced Industrial Science and Technology (AIST)), and Kaneo Chiba (REO Laboratory) recently. [1-6]

With other contributors' efforts, Micro-bubbles (micron scaled bubbles) and Nano-bubbles (nano scaled bubbles) are gathering increasing interest in industrial fields because their properties are so different from those of mill-scaled bubbles.

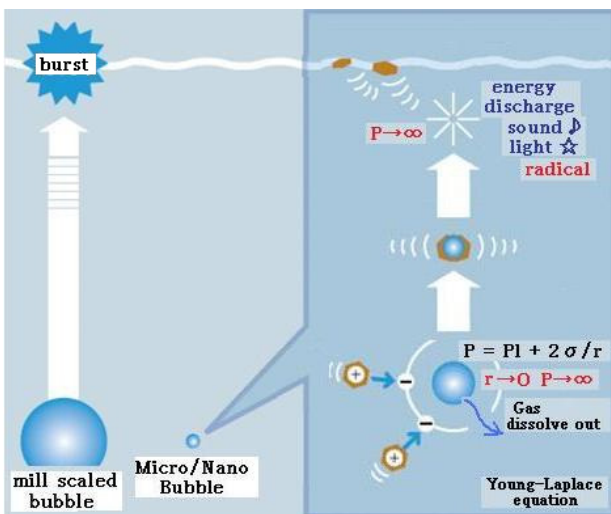

Fig.1. Micro-bubbles and mill-scaled bubbles [1]

Fig.1 schematically illustrates the differences in the behaviors between mill scaled bubbles and Micro-bubbles. The former rise rapidly and burst on the liquid surface, whereas the latter keep stable for long periods and gradually decrease in size due to the dissolution of interior gases by the surrounding liquid and eventually disappear, releasing sound or light energy, and leaving Nano-bubbles whose stability is influenced by ionic moieties in liquid. (Fig.2)

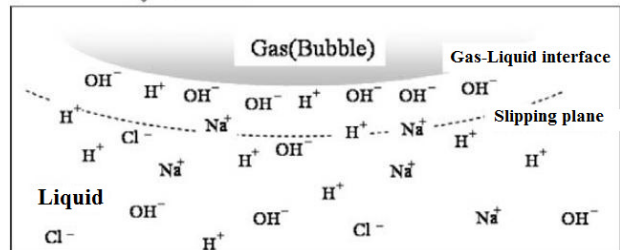
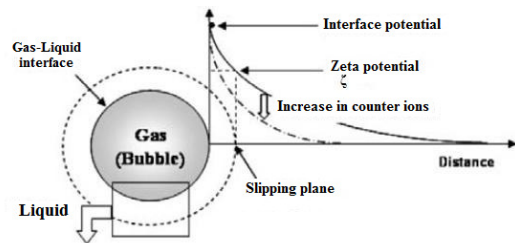

Fig.2. Gas- liquid interface and the Zeta potential [2]

The relationship between the interior gas pressure and the bubble diameter is expressed by the Young-Laplace equation:  $P = P_l + 2\sigma/r$  ( $P$  = gas pressure,  $P_l$  = liquid pressure,  $\sigma$  = surface tension,  $r$  = radius of the bubble), which explains the collapsing behavior. [6-a] It has been also proved that free radicals are generated through collapsing process of Micro-bubbles. [3-4]

Micro-bubbles look like and move like white clouds in water, which could be seen in Fig. 3 which shows an example of Micro-bubble generation.



Fig.3. Micro-bubble generation [3]

## 2. MICRO/NANO-BUBBLE GENERATOR

There are some methods of generating bubbles in water such as supplying gas through small pores or shearing gas by rotating blades; however, it is difficult to generate Micro-bubbles smaller than 50µm in diameter efficiently.

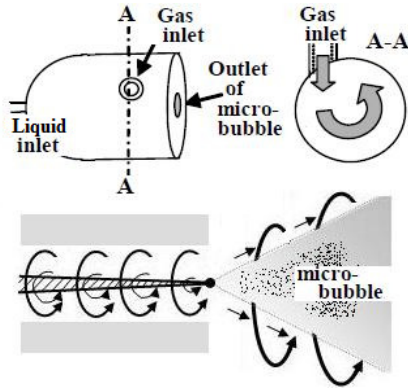

Fig.4. An efficient Micro-bubble generator [5]

One efficient generator of Micro-bubbles is shown in Fig.4, in which liquid introduced into the apparatus by a pump is spiraled along the wall, where the centrifugal force caused by the circulation introduces a gas from the gas-inlet and a vortex of gas is formed along the center axis. The gas body is separated into fine bubbles at the outlet to form Micro-bubbles. [5]

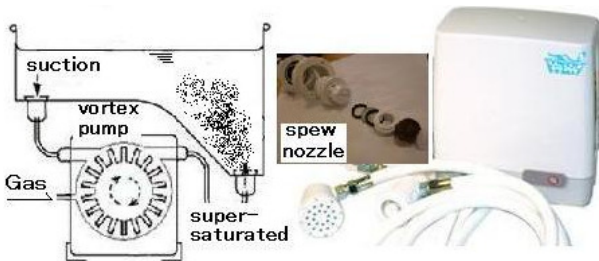

Fig.5. Another efficient Micro-bubble generator

Another example of efficient generator is shown in Fig.5, where gas is introduced from the gas-inlet into the circulating liquid inside of vortex pump, and is dissolved into supersaturated level by a high-pressure caused in the spew-nozzle. Micro-bubbles are produced from the supersaturated gas-liquid by the pressure reduction at the outside of the nozzle enhanced by the turbulent caused also in the spew-nozzle.

Other than these two examples there are a lot of generating method and devices. Generally an engineer would select an appropriate one on its cost-performance.

Nano-bubbles are selectively stabilized to be remained after Micro-bubble generation. To stabilize these Nano-bubbles, technical know-how of the usage of ionic moieties etc., is required. [6-b, c, d]

## 3. PRACTICAL BIO-APPLICATIONS

One well-known practical application of Micro/Nano-bubbles is supplying them to the culture of oysters, scallops and other marine products, the growth of which has been proved to be greatly improved. (Fig.6)

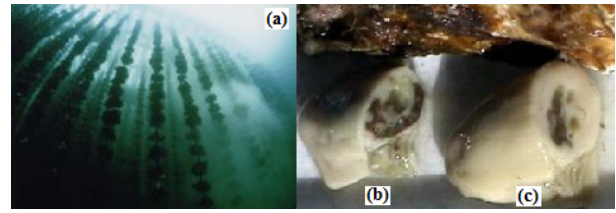

Fig.6. (a) Under water Micro-Bubbling, (b) comparing sample, (c) Oyster cultivated in Micro-Bubbling [7][8]

On the other hand, the radicals generated through Micro-Nano collapsing have also been practically used for anti-bacterial, anti-smell or purification treatment of liquids. The former is a utilization of positive bubble effect to lives; while the latter is a negative one to lives and organic matters.

Referring to the biological applications, two types of their effects on lives are used. One is a negative effect which can either break the cell walls by the radicals or be observed in refusing reaction like "mucin secretion" as shown in Fig.7.

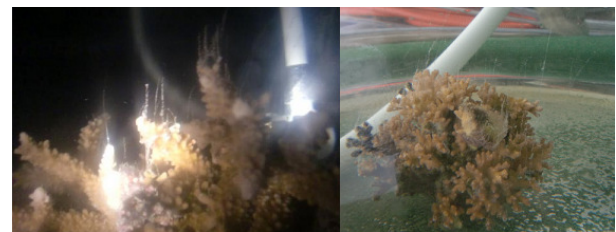

Fig.7. Corals' "mucin secretion" reaction against Micro/Nano-bubbles [see the Acknowledgements]

Another is a positive one, observable in the increase of human blood flow-rate when one takes Micro-bubble bath, or in an "accepting" behavior of lives as shown in Fig.8.



Fig.8. Turban Shell's "accepting" behavior for supplying Micro/Nano-bubbles

Himuro et al. reported the negative effect of Micro/Nano-bubbles to bacteria and positive effect to yeast, suggesting their possible application for fermentation [9]. And Ago et al. proposed a kind of Micro/Nano bubbling technology for fermentation [10].

Micro/Nano-bubbles give various effects to lives, roughly speaking, positive effect to large lives, and negative damages to small lives. That is because of their different durance against radicals, typically against active oxygen.

The effects vary from life to life, are influenced by the radius distribution and the amount of the bubbles, and inevitably affected by environmental factors including liquid temperature, liquid contents, flow rate, flow pattern, and so forth. It is so complicated that the biological applications should be prepared with great care.

#### 4. CELL-LEVEL BIOLOGICAL TREATMENT

Previous researches [9-10] have driven us to explore new development for “Cell-level” biological treatment technology using Micro/Nano-bubbles. The cell is typically of yeast; the application is typically for fermentation.

The core technology to be developed is the conditioning methodology of 1) gaseous content of the bubbles, and 2) radius distribution; both should be optimized appropriately for each treatment.

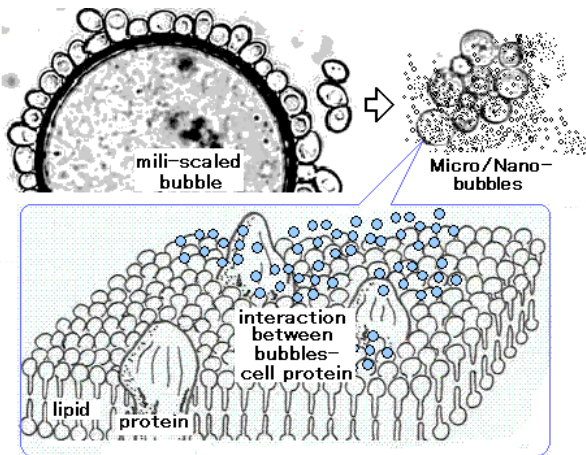

Fig.9. Cell-level biological treatment using Micro/Nano-bubbles

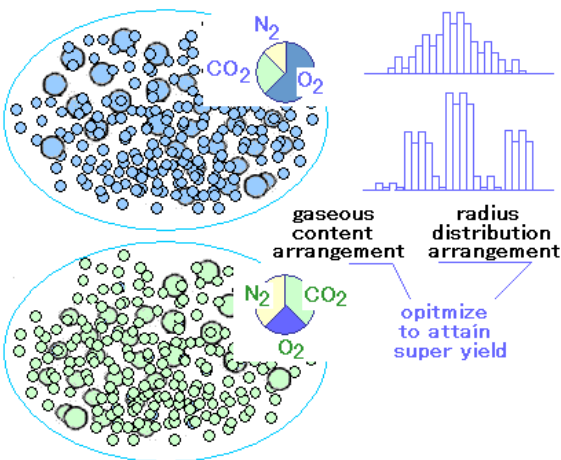

Fig.10. Optimization of bubble gaseous content for cell-level treatment

Fig.9 and Fig.10 show the core technology to be developed schematically, and Fig.11.shows the gaseous conditioner.

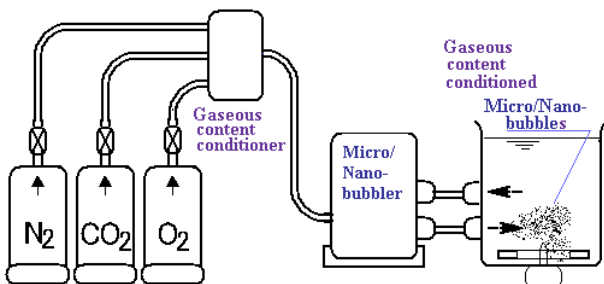

Fig.11. Gaseous content conditioner of Micro/Nano-bubbles The optimal gaseous content and the optimal radius

distribution vary from one biological application to another, from lives to lives in each application.

The control of the radius distribution of Micro/Nano-bubbles is quite difficult. There are some instruments for “in situ” continual measurement of the radius distribution using laser scattering or electrical sensing zone method, e.g. COULTER COUNTER® Analyzer of Beckman Coulter, Inc.

A method for the control of the radius distribution of Micro/Nano-bubbles is shown in Fig.12, where the position of the parts of the spew nozzle is conditioned by actuators. Broad gap makes larger radius distribution of bubble radius; while narrow gap makes smaller one. ((a) & (b) in the Fig.12) Repulsing wall makes stronger stimuli to the supersaturated liquid, resulting in more amounts of bubbles and smaller radius distribution. ((c) & (d) in the Fig.12)

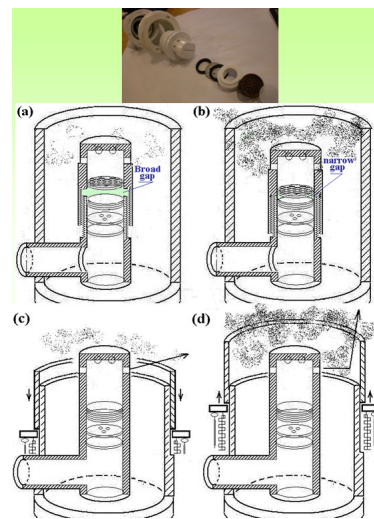

Fig.12. Conditioning the position of the parts of the spew nozzle by actuators

By utilizing such devices and methods the researches for Cell-level biological treatment are undergoing in Japan. Now the researching efforts are focused on fermentation by yeast. After the accomplishment of the fermentation, the researching effort will shift to other lives or other biological applications.

A medical research project using the Cell-level Micro/Nano-bubbles treatment has also been scheduled. Fig.13 shows the sequential enhancer of the cell endo-cytosis of the recombinant proteins for obtaining the iPS-cells. Similar trials are also undergoing for obtaining ES-cells.

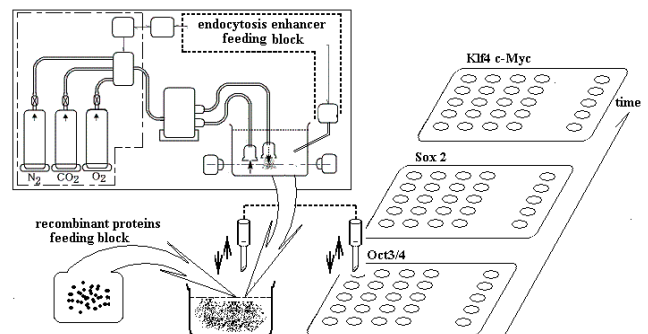

Fig.13. Sequential enhancer of the cell endo-cytosis of the recombinant proteins to obtain the iPS-cells

For attaining practical efficiencies, the Taylor vortex [11] is utilized in the treatment, typically for fermentation, which has been suffered from the problems that cells are damaged by the stirrers and the turbulent flow, resulting in unequal mixing among the inner locations of the fermentor.

The reactor utilizing the Taylor vortex has been practically used [11-14], and some trials for the cell treatment were also conducted in Japan [15-17]. The “Taylor reactor”, also called “Taylor-Couette or Couette-Taylor reactor”, “Spinning Tube in Tube reactor [12-13]” and etc. is composed of static outer cylinder and rotating inner cylinder. The reactants are fed into the annular gap between the outer and inner cylinders, where the Taylor vortex flow is induced. (Fig.14) In the flow, the cells meet and touch to bubbles mildly and such a cell-bubble mixing is expected to prevail uniformly all over the inner locations of the reactor to push up the efficiency.

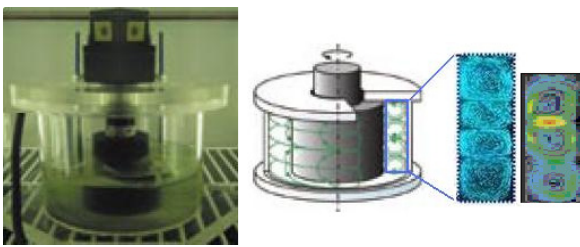

Fig.14. The “Taylor reactor” [16-17]

Fig.15 shows an additional configuration of Fig.11 applying the “Taylor reactor”.

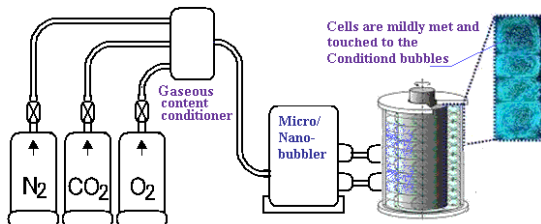

Fig.15 Cell treatment system having Gaseous content conditioner and The “Taylor reactor”

The bubbles taken into the Taylor vortex zone are known for their interesting behaviors, such as position changing between “wall” and “core” [18-19], and equally self-positioning [20-21]. The position changing behavior is shown in Fig.16, by which the bubble position could be controlled through changing the rotation speed rate of the inner cylinder. When the speed rate is relatively low, the bubbles gather near the wall of inner rotating cylinder, while high rate, the bubbles gather into the core of the Taylor vortex.

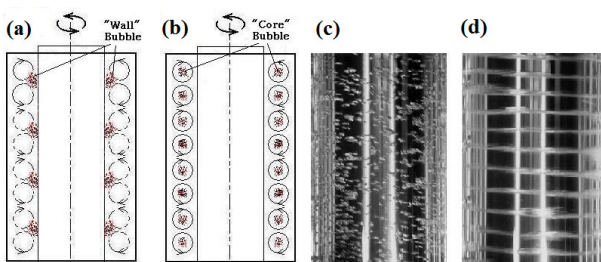

Fig.16, The “wall” and “core” bubble position control in the Taylor vortex [(a) and (c); wall, (b) and (d); core.][19]

Fig.17 shows equally self-positioning, which is suggested to be utilized digitally in the future, as well as to the integrated cell manipulator explained in the next chapter.

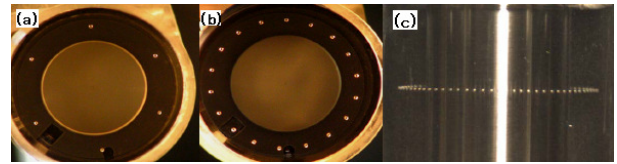

Fig.17. Equally self-positioning in the Taylor vortex [a]:6 bubbles, b):18 bubbles, c):61 bubbles] [20-21]

To avoid the clogging up of filters, a double periodic exchange circulation system is introduced; (Fig.18) by which the clogged matter on filters can be cleaned by a reversed pressure at each flow changing.

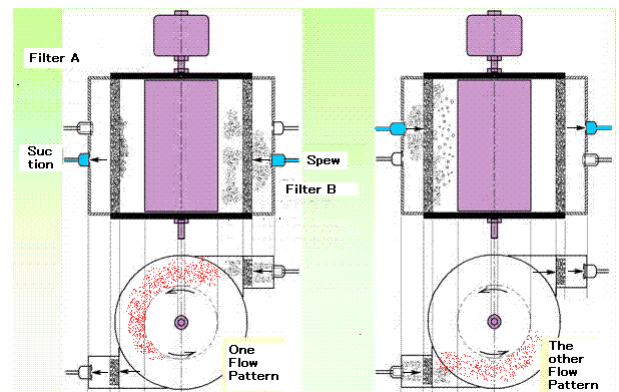

Fig.18. The double circulation system

## 5. CELL MANIPULATING DEVICE

Our next step for development is to invent a cell manipulating device to integrate the processes of cell treatments, cell separation and cell sorting.

As for the cell separation, gaseous affinity of the cell wall is used, as is shown in Fig.19, where each cell attaches to specific Micro/Nano bubbles containing conditioned gas by the gaseous affinity of cell wall. After the gaseous bubble attachment, cells could be separated easily by centrifugal separation because of different enhancement of differences of specific gravities.

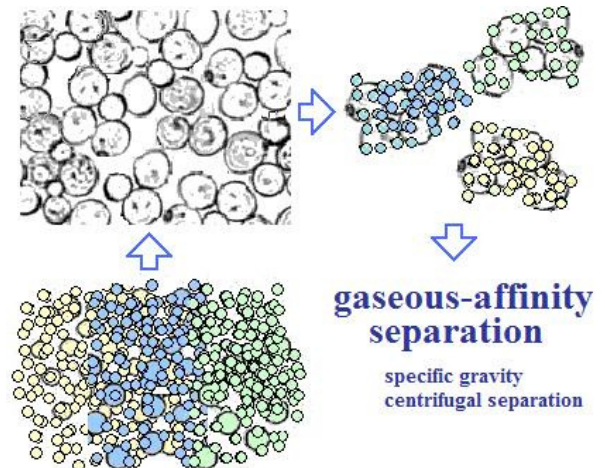

Fig.19. Gaseous-affinity separation using Micro/Nano-bubbles

Electrophoresis separation could be used if cells to be separated have enough differences in electrophoresis characteristics. Fig.20 shows “The Taylor reactor” for electrophoresis separation with electrodes.

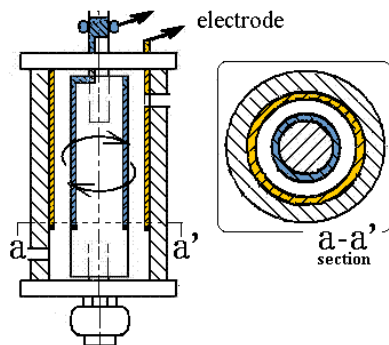

Fig.20. The “Taylor reactor” for electrophoresis separation

An example of the integrated Cell Manipulator with plurality of process zones is shown in Fig.21. Each zone has different functions, cell feed, cell treatment, cell separation and cell sorting. Some of them are combined to bubble generator to feed the zone Micro/Nano-bubbles.

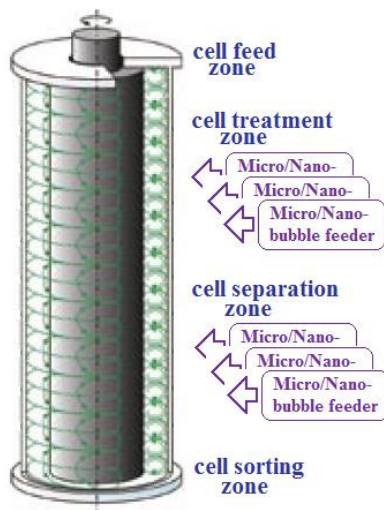

Fig.21. Integrated Cell Manipulator

## 6. FUTURE APPLICATION OF MICRO/NANO-BUBBLES WITHIN BIO-COMPUTING SYSTEMS

Considering about the Micro/Nano-bubbles on the thinking background of informatics, information is implied as the gaseous content and the radius distribution. (Fig.22)

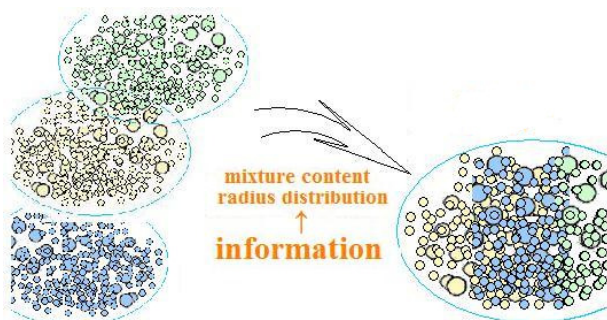

Fig.22. Bubble gaseous content and radius distribution imply information

The implementation of information suggests the future application of Micro/Nano-bubbles.

The “Taylor reactor” could be miniaturized into micron scale by using bacterial flagellar as a biological Motor, Multi-Wall Carbon Nanotube (MWNT) as a cylindrical structure and Photosynthetic cell as an energy source. (Fig.23)

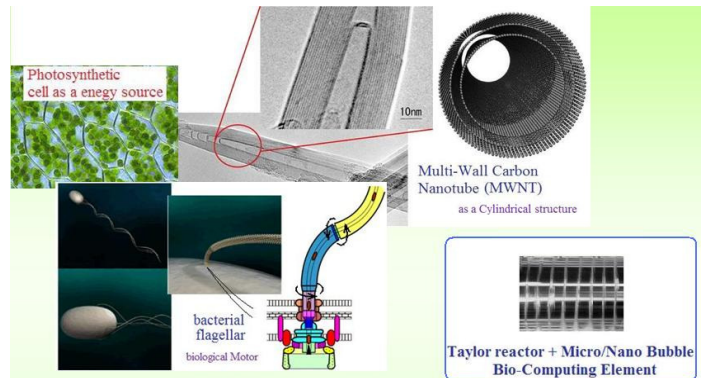

Fig.23. Future Taylor reactor for Micro/Nano Bubble-Bio Computing Element [22-24]

The miniaturized “Taylor reactor” together with the implementation of information in bubbles suggests the future Bio-Computing Element. In the element, some sorts of processor cells take on a role of conducting information processing on the input and output information in the bubbles. (Fig.24)

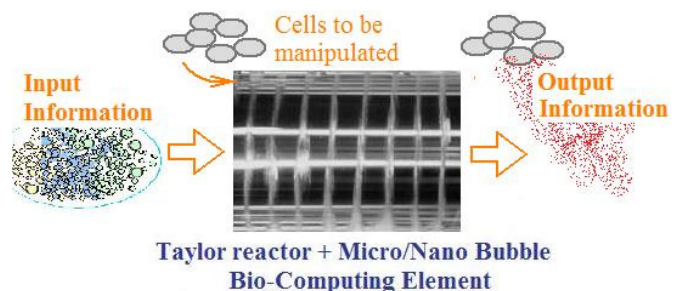

Fig.24. Information Process through the future Bio-Computing Element

Though the above is still a conception at the present, surely active researches will turn it to the real in the future. [26]

## 7. CONCLUSION

Micro/Nano-bubbles have a lot of promising applications. By many contributors, the research and the practical applications have got a good progress gradually but steadily. I wish this article to make another encouragement to the research and development activities.

## ACKNOWLEDGEMENTS

The experiment of Fig.5 using natural corals was conducted on the courtesy of the *AKAJIMA MARINE SCIENCE LABORATORY (AMSL)\**, on behalf of corals-protection project, which is gratefully acknowledged by the author with special thanks to the advices and the experimental effort of *Researchers Hiroki Taniguchi and Kenji Iwao*

*\*) 179 Aka, Zamamison, Okinawa, 901-3311 JAPAN*

## REFERENCES

- [1] Takahashi, M. Kawamura, T. Yamamoto, Y. Ohnari, H. Himuro, S. Shakutui, H. "Effect of shrinking micro-bubble on gas hydrate formation", **J. Phys. Chem. B** 107, pp.2171-2173(2003).
- [2] Takahashi, M. "ζ potential of micro-bubbles in aqueous solutions: electrical properties of the gas/water interface", **J. Phys. Chem. B** 109, pp.21858-21864(2005).
- [3] Takahashi, M. Chiba, K. and Li, P. "Free-radical generation from collapsing micro-bubbles in the absence of a dynamic stimulus", **J. Phys. Chem. B** 111, pp.1343-1347 (2007).
- [4] Takahashi, M. Chiba, K. and Li, P. "Formation of Hydroxyl Radicals by Collapsing Ozone Micro-bubbles under Strong Acid Conditions", **J. Phys. Chem. B** 111, pp.11443-11446 (2007).
- [5] Ohnari, H. **US Patent** 6382601 "Swirling fine-bubble generator"
- [6] Chiba, K. and Takahashi, M. **International Patent Application** a)WO2005-030649 "Crush of Micro Bubble" b)WO2005-084718 "Method for Producing Nano-Bubble" c)WO2005-084786 "Water Containing Oxygen Nano Bubbles and Method for Producing thereof", d)WO2005-085053 "Oxygen Nano-bubble Water and Method of Producing the Same"
- [7] Ohnari, H. "Micro bubble technology, its Characteristics and Possibilities" (in Japanese), **Journal of MMIJ** Vol. 123 (2007), No.3 pp.89-96
- [8] Nakayama, T. "Improvement of Oyster Cultivation by Micro-Bubbles"(in Japanese), session-14, 5th **Conference on Symbiotic Environmental Systems Engineering** of Yamaguchi Univ. (2006)
- [9] Himuro, S. Deguchi, T. Takamatsu, R. "Effects of Micro-bubbles on Bacteria" (in Japanese) **Progress in Multiphase Flow Research** Vol. 4 (2009) pp.95-102
- [10] Ago, K. Nagasawa, K. Takita, J. Itano, R. Morii, N. Matsuda, K. and Takahashi, K. "Development of an Aerobic Cultivation System by Using a Micro-bubble Aeration Technology" **Journal of chemical Engineering of Japan** Vol. 38 (2005), No. 9 pp.757-762
- [11] Taylor, G.I. "Stability of a Viscous Liquid contained between Two Rotating Cylinders", **Phil. Trans. Royal Society A**223: 289-343. doi: 10.1098/rsta.1923.0008. (1923)
- [12] Holl, R.A., et.al **US Patent** 7098360 "Processes employing multiple successive chemical reaction process steps and apparatus therefore"
- [13] Kredo Biofuel Co., Ltd **International Patent Application** WO2007-109628 "Esterification and transesterification Systems, methods and apparatus"
- [14] Korea Non-Destructive T&i Co., Ltd **International Patent Application** WO2009-151159 "Crystallization Reaction Apparatus for preparation of massive crystalline particles and crystalline separation Processing system"
- [15] Siragami, N et al. **JP Patent** 2752918"Micro-carrier cultivation of Animal Cell"(in Japanese)
- [16] Yasui, S. Kawai, H. "Cultivation of Photosynthesis Microorganism in Taylor-Couette Vortex Flow", **Journal of the Visualization Society of Japan**, Vol.28 No.Suppl.1 pp.415-418 (2008) (in Japanese)
- [17] Kawai, H. Yasui, S. Kikura, H. "Cultivation of Photosynthesis Microorganism in Taylor-Couette Vortex Flow", **Journal of the Visualization Society of Japan**, Vol.29 No.Suppl.1 pp.247-248 (2009) (in Japanese)
- [18] Murai, Y. Oiwa, H. and Takeda, Y. "Bubble behavior in a vertical Taylor-Couette flow, **Journal of Physics: Conference Series** 14 (2005) pp.143-156
- [19] Shiomi, Y. Nakanishi, S. Kutsuna, H. "CFD Calculation for Two-Phase Flow in Concentric Annulus with Rotating Inner Cylinder", Proc. Eighth International **PHOENICS Users Conference** 2000
- [20] Byk, L. Lavrenteva, O. Spivak, R. Nir, A. "Interaction and Ordering of Bubbles Levitated in Vortical Flow", **Microgravity sci. technol.**Vol.19, Numbers 3-4, 78-80, doi: 10.1007/BF02915758
- [21] Deng, R. Wanga, C-H. Smith, K.A. "Bubble Behavior in a Taylor Vortex", **Phys. Rev. E** 73, 036306-1-4 (2006)
- [22] Minamino, T., Imada, K. and Namba, K "Mechanisms of type III protein export for bacterial flagellar assembly", **Molecular BioSystems** 4, 1105-1115. (2008)
- [23] Minamino, T. and Namba, K. "Distinct roles of the ATPase and proton motive force in bacterial flagellar protein export", **Nature** 451, 485-488. (2008)
- [24] Iijima, S. "Helical microtubules of graphitic carbon", **Nature** 354: (1991) pp.56-58. doi: 10.1038/354056a0.
- [25] Marui, T. **JP Patent Application**[Toku-Gann] (a) 2009-234683 "M/N-Bubbles containing Conditioned gas and their Biological Applications", (b)2009-282840 "Conditioned gas containing M/N-Bubbles generation method and generator for Biological Applications", (c)2009-278427 "Couette-Taylor Reactor for Continuous Electro-chemical reactions", (d)2010-000569, "Control method of the radius distribution of Conditioned gas containing M/N-Bubbles generator", (e)2010-012727, "Biological Reactor using Couette-Taylor flow and M/N-Bubbles and the Biological Applications", (all of them in Japanese and not yet officially opened.)
- [26] Amos, M. "Genesis Machines - The New Science of Bio-computing", **Atlantic Books** (2006) ISBN 1-843-54224-2.